



CLADS™

EXTERIOR GRADE COMPACT LAMINATES



TECHNICAL MANUAL

BE BEAUTIFUL ON THE OUTSIDE



In this booklet we'll provide you with all technical information regarding Greenlam CLADS exterior grade compact laminate panels which have been designed especially for outdoor applications. Greenlam CLADS not only offers panels for the rear ventilated façade, but the properties of our panels qualify them for all other outdoor applications –balconies or railing fillers, sunblinds, porches, etc.

There are many other applications of CLADS panels.

If you have any questions, which are not answered in this booklet, please get in contact with our sales representatives or technical support team.

We will be pleased to help you.

For more information, log on to www.greenlamclads.com or write to us at info@greenlam.com

Contents

• The Product	04
• Usage & Application	05
• Cladding Façades- An Overview	16
• Product Offering- Range, Size, Thickness	18
• Quality & Benefits	20
• Product Construction	21
• The GLE Technology	22
• Working Recommendations	23
• Product Technicals	26
• Greenlam Clads – Recommended Installation Methods	
• Visible Rivets fastening on Aluminum Substructure	28
• Secret Glued fastening on Aluminum Substructure	34
• Range Offering	40

Greenlam CLADS – The Product

After beautifying the globe with this magnum opus, Greenlam now endeavors to adorn the world with its revolutionary exterior surfacing panels 'CLADS'. These stunning exterior surfacing panels are designed to make your exteriors enthralling and gripping. CLADS exterior grade compact laminates come with a revolutionary unmatched GLE Technology that makes them fade-resistant, weather-proof and fire-resistant, and hence apt for exteriors.

Greenlam CLADS is a versatile product which finds usage at any and every place which calls for withstanding exterior climate.

This section details out various areas where a Greenlam CLADS exterior grade compact laminate is apt to use or can be used.

- Rear ventilated facades
- Façade claddings
- Balcony claddings
- Partitions
- Railings
- Fences
- Attic claddings
- Ceilings
- Outdoor furniture
- Public facilities
- Playground facilities
- Sports facilities
- Sun protection
- Awnings
- Business entry portals
- Functional constructions

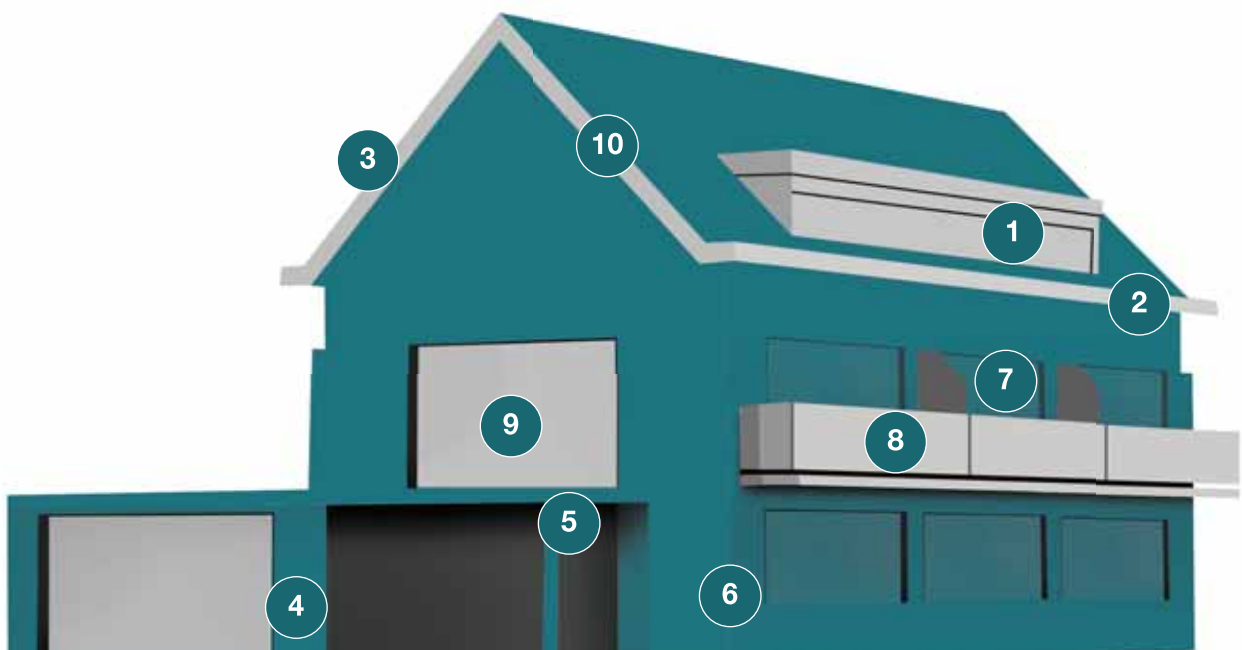

Usage & Application: Greenlam CLADS

Façades

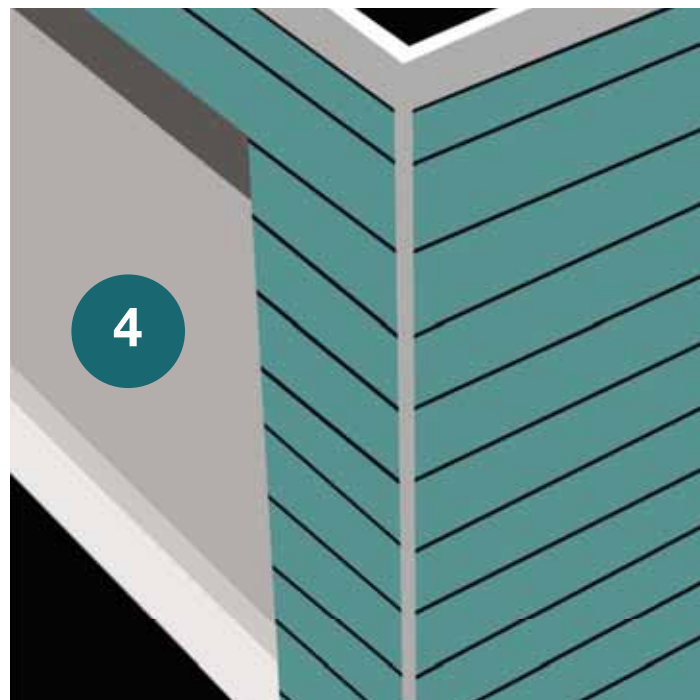
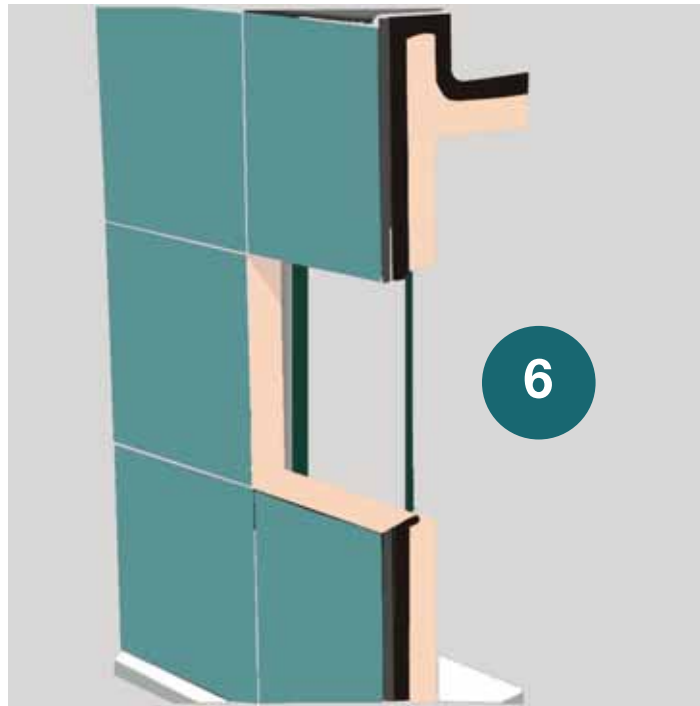

Usage & Application: Greenlam CLADS

Soffits

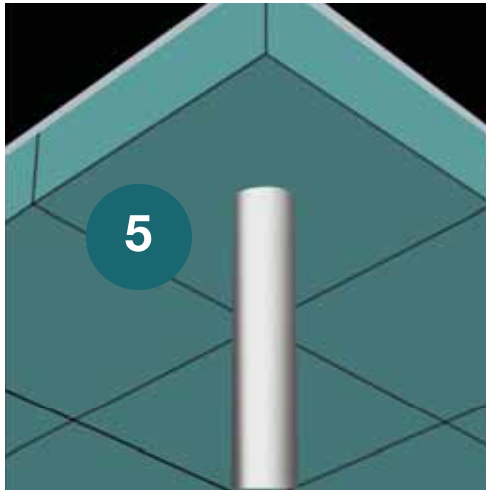

Windows

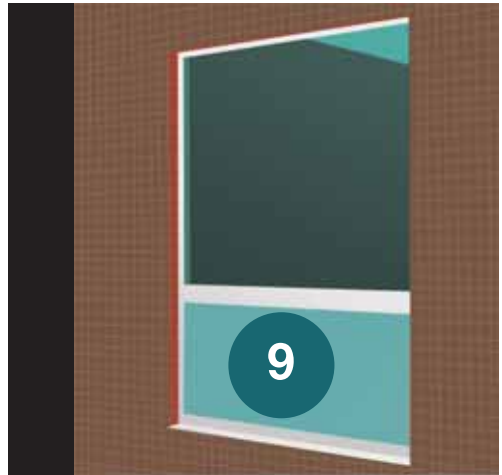

Roofs and Awnings

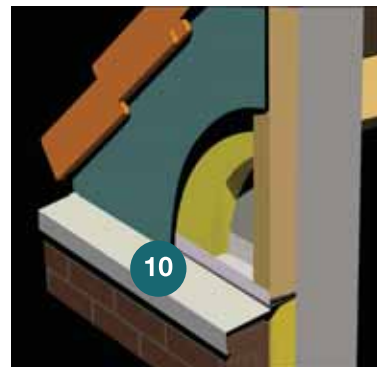
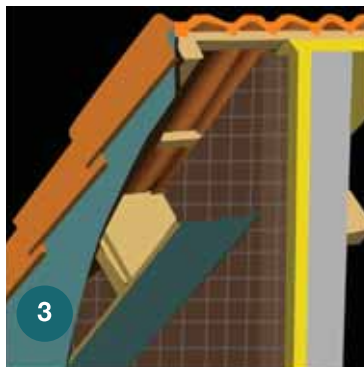
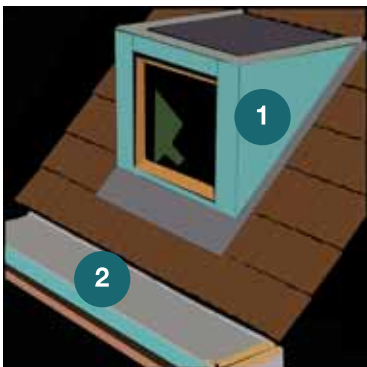

Balconies

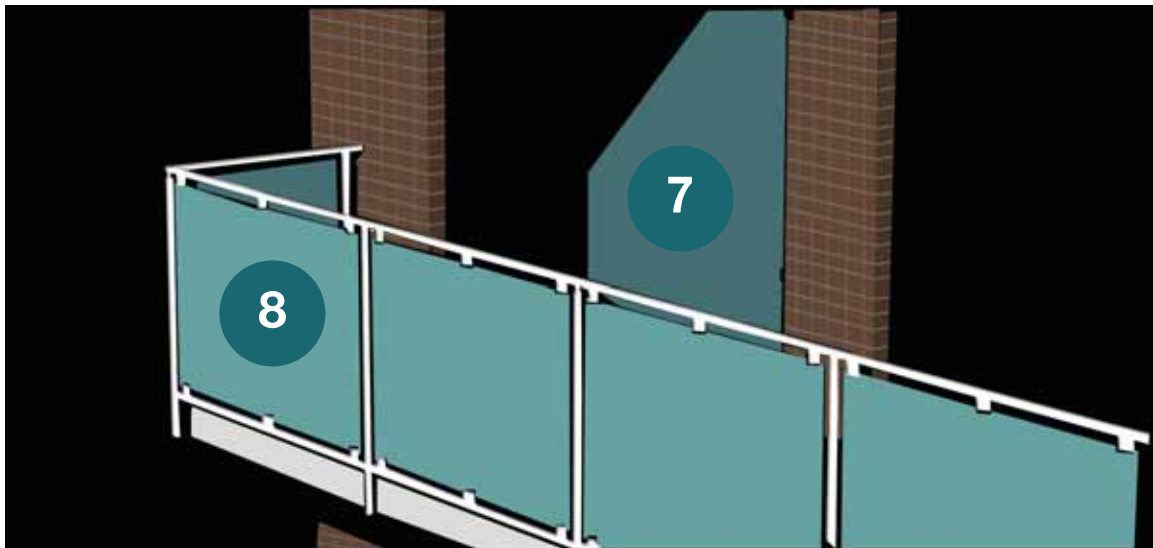

Usage & Application: Greenlam CLADS



Usage & Application: Greenlam CLADS



Usage & Application: Greenlam CLADS



Usage & Application: Greenlam CLADS



Usage & Application: Greenlam CLADS



Usage & Application: Greenlam CLADS



Usage & Application: Greenlam CLADS

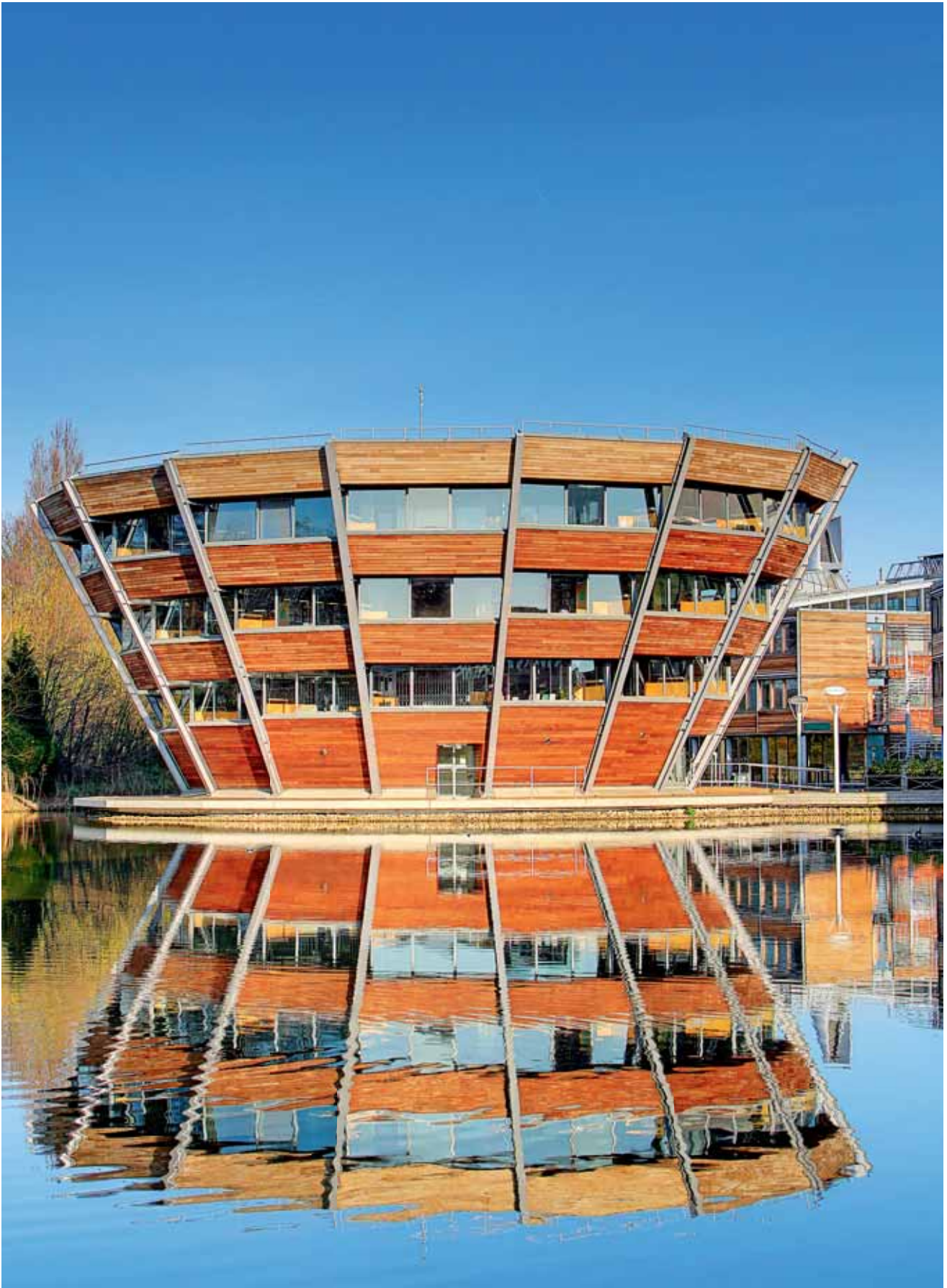

Usage & Application: Greenlam CLADS



Usage & Application: Greenlam CLADS

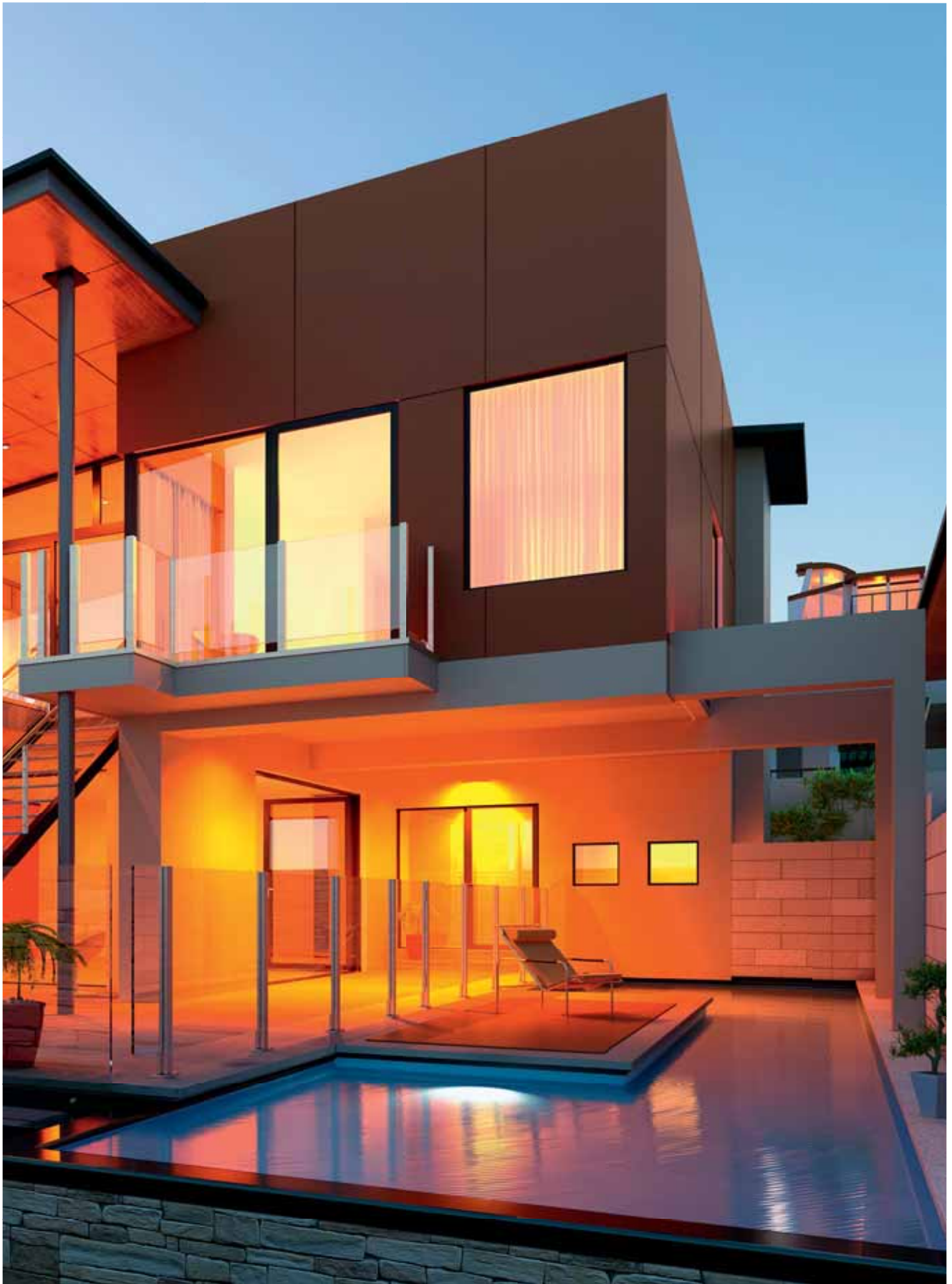

Cladding Façades – An Overview

One and the most extensively used application of Greenlam CLADS – Exterior Grade Compact laminates is Building Façades. Cladding the building facades over the traditional material options lends various advantages, few of them are highlighted as under.

Advantages of the non-bearing, rear-ventilated façade (VHF):

- Savings through the shorter scaffolding times
- Installation under any weather conditions
- Exact cost estimation of the facade
- No disposal costs during the installation phase
- Long maintenance intervals and low follow-up costs
- Long-term value retention and appreciation of the building

Function of a non-bearing, rear-ventilated façade

• Insulation

The non-bearing, rear-ventilated facade (VHF) system can be designed for different energy requirements with an individually calculated insulation. Insulation material of any desired thickness can be used. This means insulation values can easily be achieved that are typical of low-energy houses and comply with the current energy savings regulations. Based on the energy needs, the insulation maximises the heat retention of the building. High summer temperatures in the interior of the building are regulated. By reducing the amount of energy needed for heating, the non-bearing façade minimises the carbon dioxide emissions of the heating system.

• Protection against condensation of water

The construction of the non-bearing, rear-ventilated facade (VHF) decreases the vapour diffusion resistance from the interior to the exterior of the building: Moisture from the construction or use of the building is removed through the rear-ventilation space. Thus the lasting function of the insulation can be ensured which makes a significant contribution to a pleasant and healthy indoor climate.

• Protection against rain

The VHF meets the norms for stress group III according to DIN 4108-3 and is driving-rain proof. The rear ventilation space between insulation and panel (weather protection) quickly dissipates moisture.

• Protection against noise

Depending on the thickness of the insulation layer, measurements of the panels and the proportion of open joints, noise protection can be increased by up to 14 dB.

• Ecology

Minimisation of CO₂ emissions.

Environmental objectives are fulfilled both for new buildings, as well as for renovation of existing buildings, through the use of rear-ventilated facades. The measurable reduction in energy required for heating minimises the carbon dioxide emissions, one of the greatest causes of environmental pollution. State and regional subsidy programs are still available for energy-saving facade renovations.

Cladding Façades – An Overview

- **Economy**

The economic aspects can also be found again in the requirements of sustainable construction: Long service life, long maintenance intervals and the subsequent return of the components to their resource cycle are the essential points.

- **Cost certainty**

The cost estimation for a non-bearing, rear-ventilated facade, even in the case of renovations is basically an exact cost planning.

Basics of construction:

During construction and installation, care is to be taken that the material is not exposed to standing water. This means that the panels must always be able to dry out. Connections of CLADS panels to one another always have to be made in the same panel direction. CLADS can show deviations from being flat (see EN 438-6, 5.3), and this is to be compensated for by the sub-construction being executed so that it is stable and flat. All connections to other components or to the background must be executed firmly. Elastic intermediate spacers to the sub-construction elements and also between sub-construction elements which permit a greater tolerance than +0.5 mm must definitely be avoided.

Range Offering

21 DESIGNS TO LEAVE YOU AWESTRUCK



PLAIN COLOURS

We offer designs in about 5 prime colours extensively in demand for exteriors even with ACP & exterior grade compact products.

WOOD PATTERNS

Offering exotic designs based on wood grains closest to the exterior grade timber.



ABSTRACTS

A special visual delight, designed to lift your décor moods and settings. Now make a statement with extremely fashionable designs CLADS from Greenlam.

FASTENING

Greenlam Clads comes along with essential fasteners made using non-corrosive materials like Aluminium & Stainless Steel. Big head of these fasteners(rivets) are colour lacquered with epoxy paints so as to compliment the Greenlam Clads range and are UV coated for better color fastening properties.

Rivet body : Aluminum Alloy 5052

Rivet Pin : 302 AISI

Pull off strength of rivet pin: Min. 4626N & Max 5382N

Diameter of drill hole in Greenlam CLADS panels:

- Sliding points: 8.5 mm or as required
- Fixed points: 5.1 mm
- Diameter of drill hole in the aluminium substructure: 5.1 mm

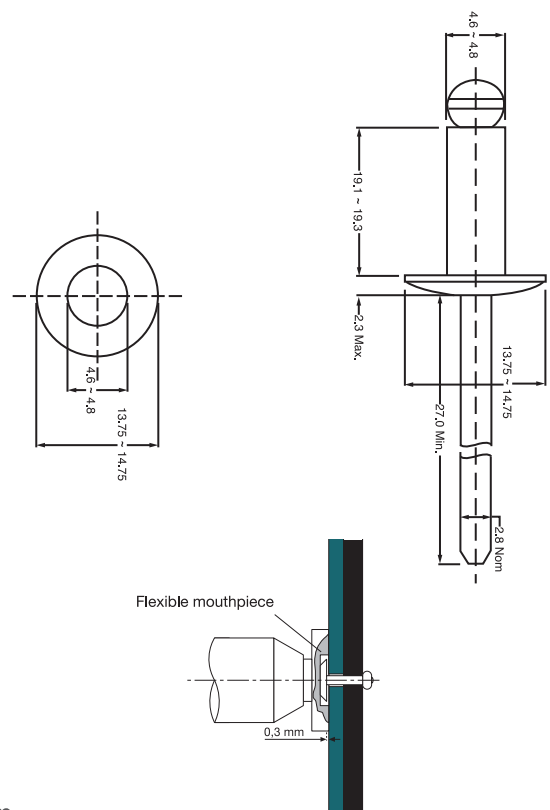

The rivets must be put in place with a flexible mouthpiece, clearance 0.3 mm

Greenlam CLADS Offering

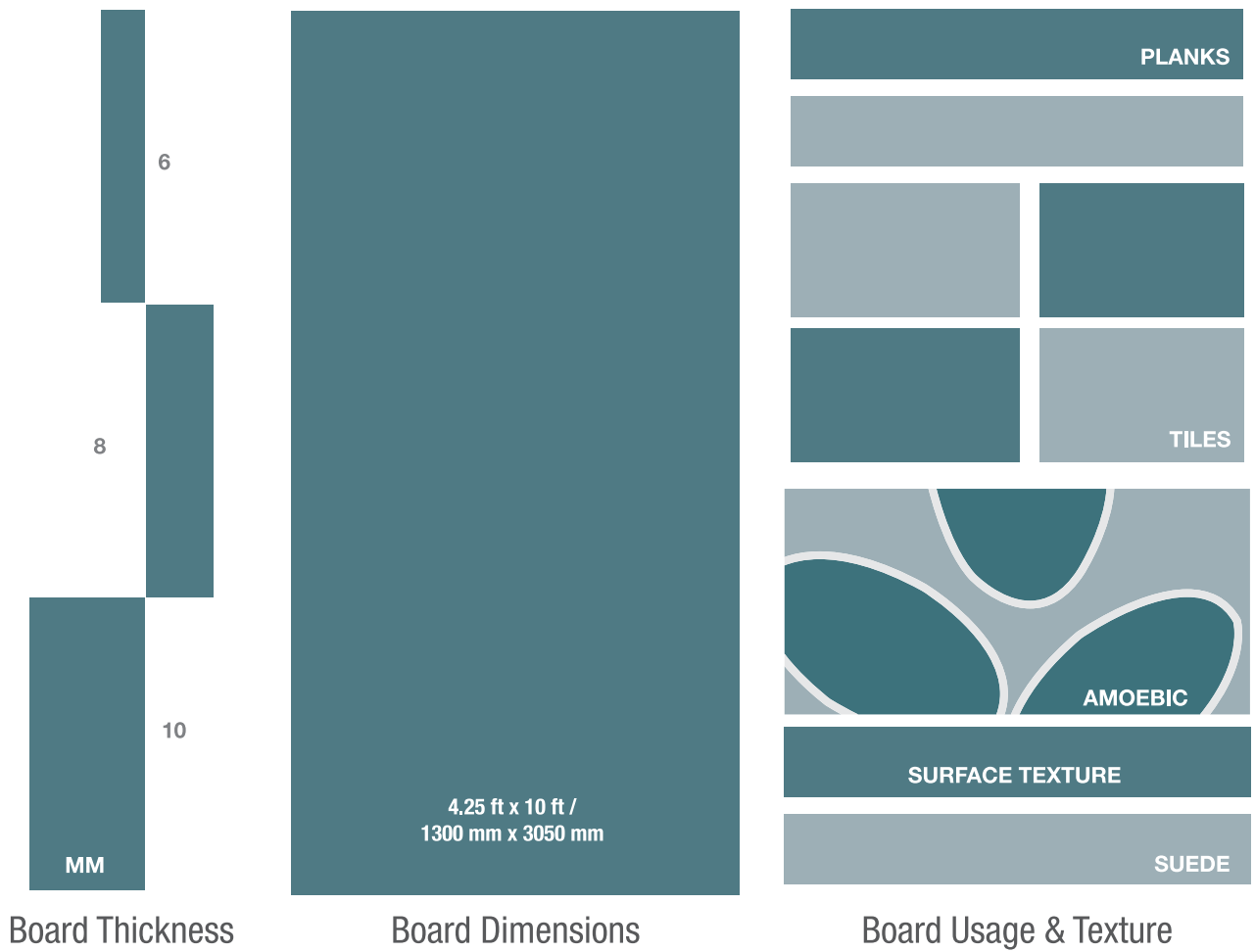



Greenlam CLADS – Weight Information			
Thickness	Width	Length	Weight
6 mm	4.25 ft / 1300 mm	10 ft / 3050 mm	35 kgs
8 mm	4.25 ft / 1300 mm	10 ft / 3050 mm	46 kgs
10 mm	4.25 ft / 1300 mm	10 ft / 3050 mm	57 kgs

Greenlam CLADS – Quality & Benefits

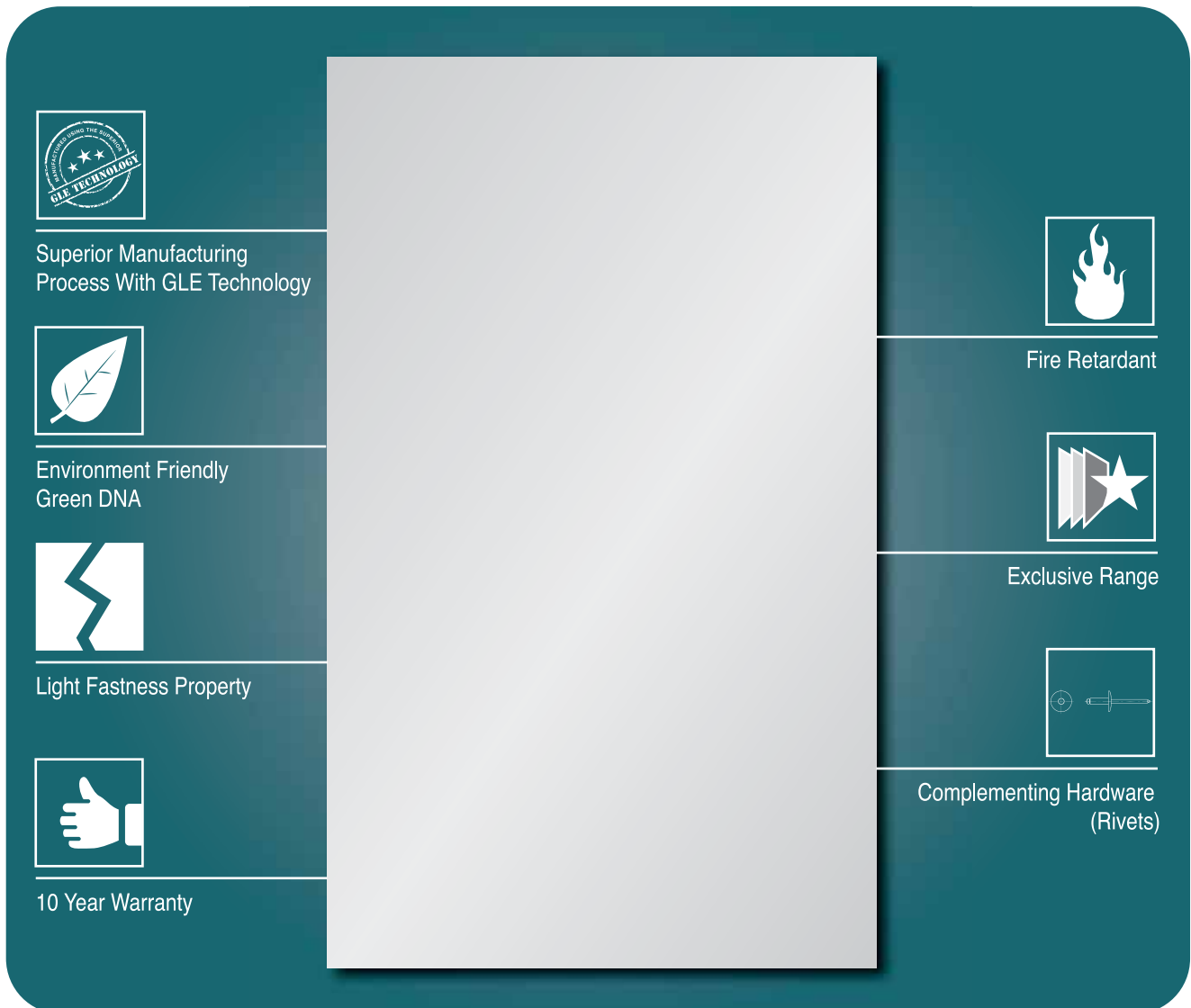
Greenlam CLADS are superior quality Exterior Grade High Pressure Laminates made in accordance with EN 438-6 Type EDF, produced in lamination presses under great pressure and high temperatures. These panels are best suited for installation as ventilated façade systems. It provides breathing space for building, thus creating a vent for the internal moisture to release. Not only this, it also protects buildings from excess cold in winter and provides silence by reducing exterior noises without applying any insulation.





Superior Manufacturing
Process With GLE Technology



Environment Friendly
Green DNA

Light Fastness Property

10 Year Warranty

Fire Retardant

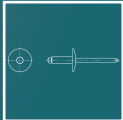
Exclusive Range



Complementing Hardware
(Rivets)

Properties:

- Weather resistant to EN ISO 4892-2
- Lightfast acc. to EN ISO 4892-3
- Double hardened
- Scratch resistant
- Solvent resistant
- Hail resistant
- Easy to clean
- Impact resistant EN ISO 178
- Suitable for all exterior applications
- Decorative
- Self-supporting
- Bending resistant EN ISO 178
- Frost resistant -80°C to 180°C (DMTA- OFI 300.128)
- Heat resistant -80°C to 180°C (DMTA- OFI 300.128)
- Easy to install

Greenlam CLADS – The construct

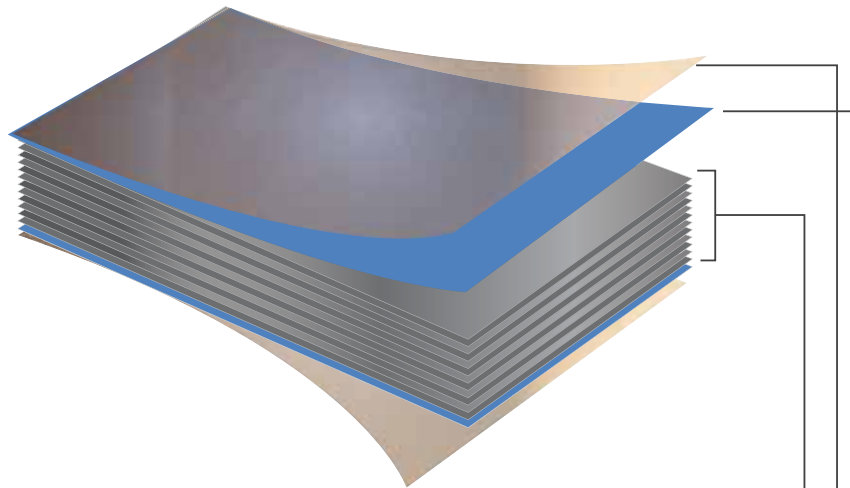
Greenlam Clads are self-supporting high pressure laminate (HPL) with a decorative surface that is suitable for exteriors. It is fade-resistant and weather-proof and complies with standard EDF- (EN 438- 6 Fire Retardant). The laminates are treated with special chemicals which make them Fire Retardant. Hence, in case of fire these prevent further provocation of fire.



PRODUCT CONSTRUCTION

- 1- Special Polymeric Film for Surface Protection
- 2- Special Exterior Decor Paper Impregnated with Thermosetting Resin
- 3- Brown Kraft Core Treated with Special Chemicals in Phenolic Resin

The product is made up of:

- 1) Layers of kraft paper impregnated with halogen-free FR grade phenolic resin, making the product fire-retardant.
- 2) Both side special exterior grade decorative paper surface made using extreme light stable pigments and special chemical & inks, impregnated with melamine resins. The decor paper is rated 7-8 on Blue wool scale & 3-5 on Grey scale, hence making it fit for use on exteriors.
- 3) A special UV protective polymeric layer on the top & bottom. This protective layer protects Greenlam CLADS when exposed to the combined action of sunlight and atmospheric agents such as rain, hail, wind and salt deposits. These phenomena do not affect the decorative surface or the core. Exhaust fumes and acid rain have no significant effect on the surface.

The Superior GLE Technology:

The GLE Technology from Greenlam R&D team makes Greenlam Clads a sturdy product that can withstand extreme weather conditions and makes it perfect for exterior use.

This technology/process of making the product is based on 3 main pillars:

1. Superior Manufacturing Process
2. Superior Décor Paper
3. Special Protective Surface Film

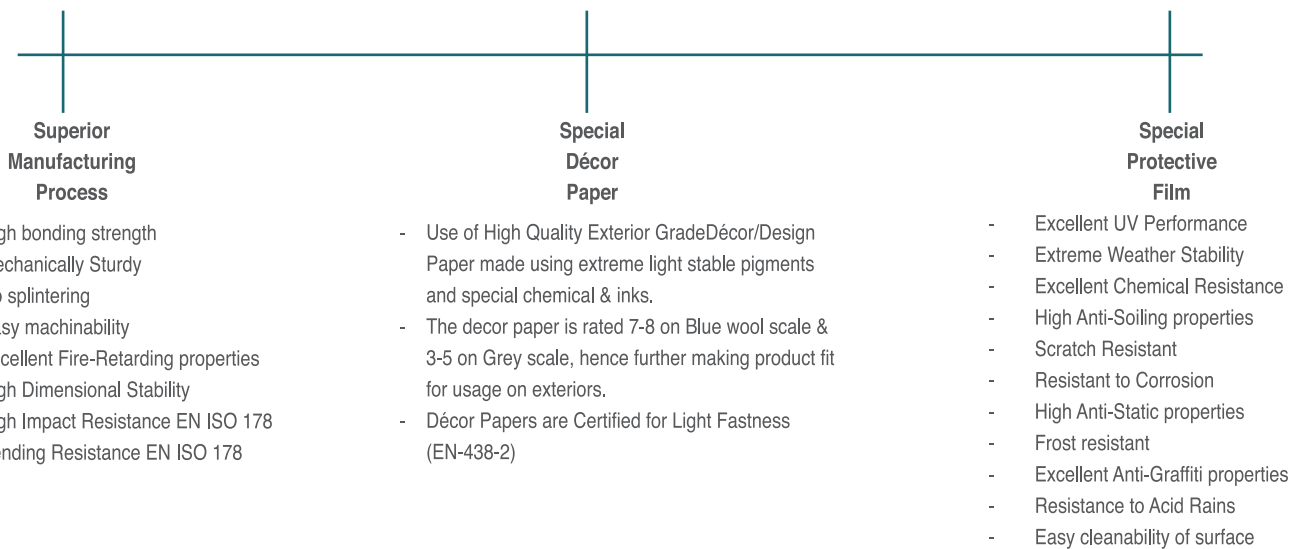

Greenlam CLADS – Working Recommendation

Material Characteristics - Expansion & Contraction

High Pressure laminates have a tendency of dimensional change when exposed to various temperature & humidity conditions. So Greenlam CLADS also shrinks when they loose moisture and expand when they absorb moisture.

Hence, when working and constructing with our panels, consideration must be given to this possible dimensional change and appropriate expansion or contraction clearance should be given while installing the product. For Greenlam CLADS, it is basically half as much lengthways as widthways (Refer Physical Properties table; lengthways is relative to the nominal panel format)

Element length = X

Element width = Y

X or Y (in mm)

———— = Expansion Clearance

500

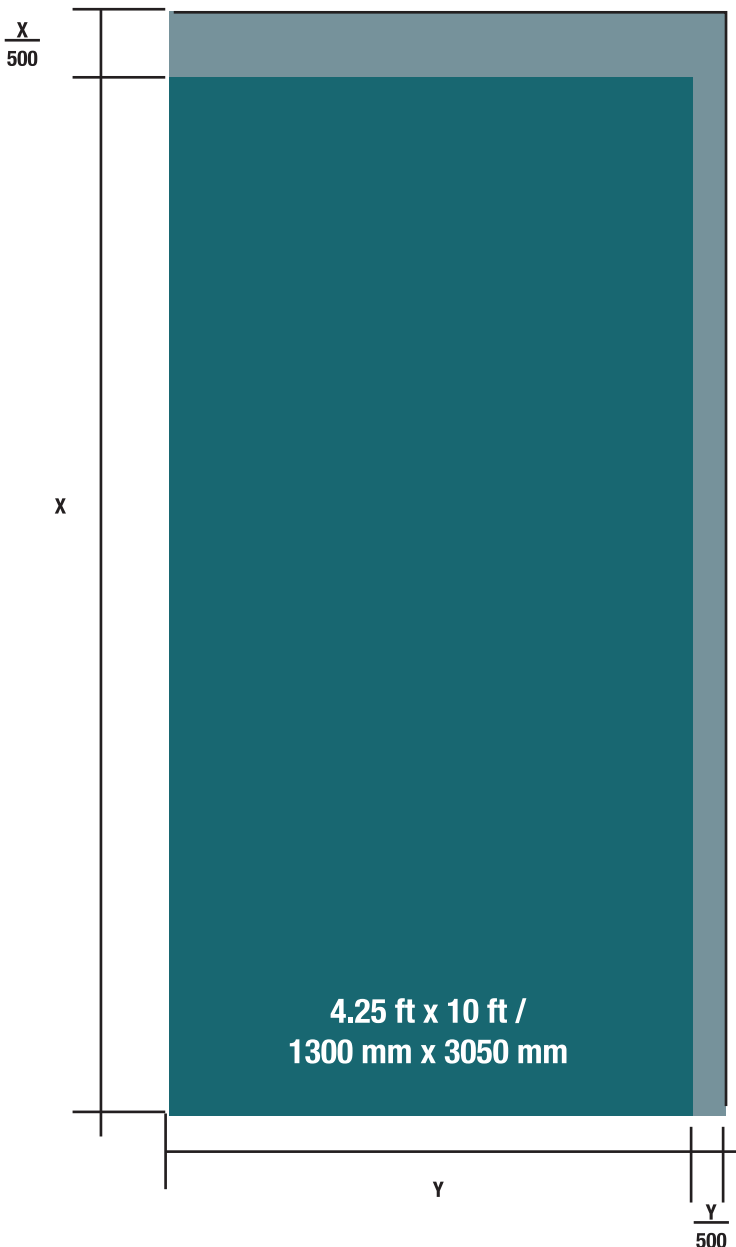

Greenlam CLADS – Working Recommendation

Transport and Handling

Handle CLADS panels with care in order not to damage the edges and surfaces of the high-quality material. In spite of the excellent surface hardness and the installation protection film, the stack weight of CLADS is a possible cause of damage. Therefore, any form of dirt or dust between the panels must definitely be avoided.

Greenlam CLADS must be secured against slippage during transport. When loading or unloading, the panels must be lifted. Do not push or pull them over the edge.

Installation protection films must always be removed from both sides. This protection film must not be exposed to heat or direct sunshine.

Storage and Air Conditioning

Greenlam CLADS panels must be stacked horizontally on flat, stable supports and supporting panels. The goods must lie completely flat. After removal of panels, PE films must again be closed over the stack. The same applies, in principle, for cut-panel stacks. Incorrect storage can lead to permanent deformation of the panels. CLADS panels are to be stored in closed rooms under normal climatic conditions, duly wrapped with PE film. Climate differences on the two surfaces of a panel are to be avoided.

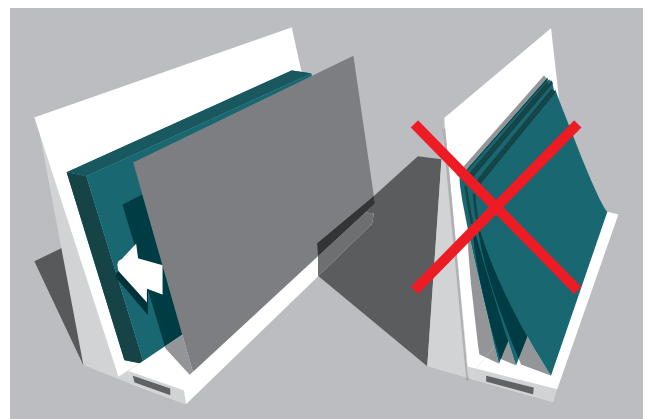
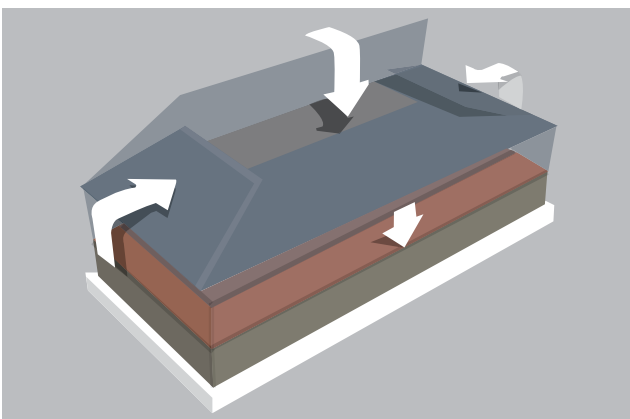
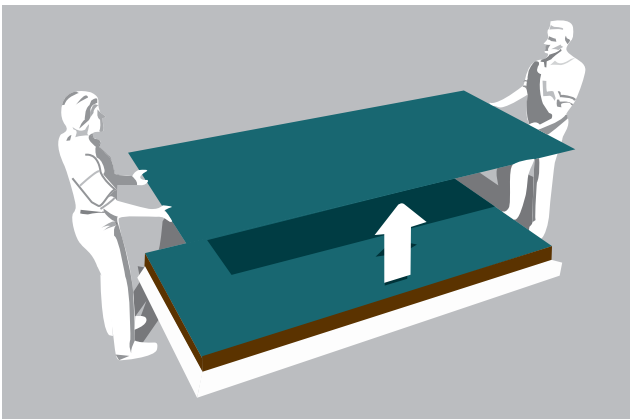

Greenlam CLADS – Working Recommendation

Machining

CLADS can be easily machined with carbide-tipped woodworking tools like hardwood, laminated chipboard or bonded chipboard. Saw with stable circular saws or hand-held circular saws for installation cutting. All world-renowned producers of hand-held machines like Festo, Bosch, and many others offer guide rails. Carbide-tipped saw blades with (group) trapezoidal teeth FZ/TR - (for e.g., Leitz) have produced good results. To achieve good cutting quality, feed CLADS as smoothly as possible.

Cutting rate: 50-60 m/sec depending on tool diameter and rpm, for e.g., 4000 rpm, Diameter 250 mm, 64 teeth.

Depth of cut per tooth: 0.02 - 0.04 mm

Feed: 6 - 10 m/min depending on thickness

Sharp saws and optimum setting of the saw blade projection are necessary in order to achieve clean cut edges. For fitting work and chamfering on the construction site, electrical hand planes with a chamfering or a mitring groove have proven themselves. Use HSS twist drills for manual drilling. Drill tip $\leq 90^\circ$. When using carbide-tipped drills, use pillar drilling machines - carbide metal tends to break off when drilling by hand. Drill against an appropriate base applying enough pressure to ensure a clean exit hole.

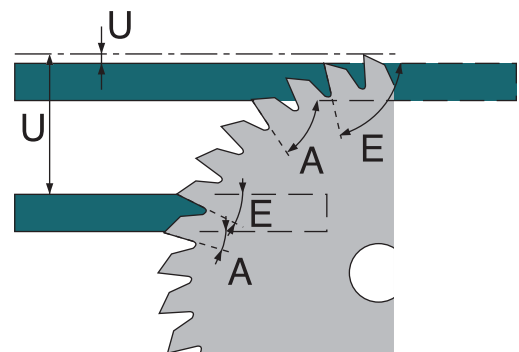
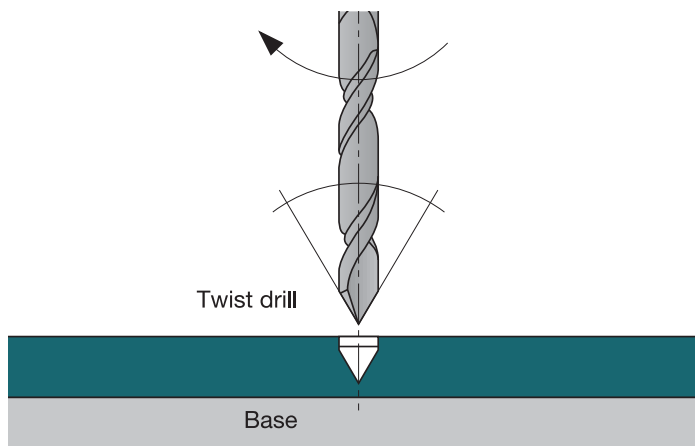

If the projection 'U' becomes greater, the top cut edge gets better and the bottom cut edge worse, and vice versa.

E = Entry angle

A = Exit angle

DONT's : It is not advisable to cut the Greenlam CLADS panels with hand saw as it may lead to non uniform finishing of edges.

Cleaning

CLADS has a hygienic, sealed surface that needs no additional care. Cleaning is necessary under certain circumstances. This is most easily done as follows: for cleaning purpose, use unsoiled, warm water, clean cloth or rags, and soap (housework-related cleaners which are sold in shops). Avoid scouring substances.

Although the adhesion of inks/paints is very low on the Greenlam Clads Panels, we recommend not to clean the surface dry or by using any tools. The risk of damaging the top special polymeric surface is too high. An alternative for removing graffiti is to use a high-pressure-cleaner. Alternatively, solvent cleaners could be used for removing varnishes, paint sprays (graffiti), and other similar stains and marks. Greenlam CLADS recommends using Graffinet® Plexiclean & Magnus 1302 from Henkel to address the graffiti related cleaning issues.

Technical Offering:

PHYSICAL PROPERTIES

PROPERTIES	TEST METHOD AS PER DIN EN 438 Part 2&3:2005	Unit of Measurement	SPECIFIED VALUES AS PER BS EN 438-4 :2005	RESULTS GREENLAM CLADS
	EN 438 Classification		EGS/EDS/EGF/EDF	
Dimensional Tolerances of Panel				
Flatness of Panel	EN 438-2 : 9	mm/m mm/m	For $2.0 \leq t < 6.0\text{mm}$: max 8.0mm/m For $6.0 \leq t < 10.0\text{mm}$: max 5.0mm/m	3.5 2.2
Length & Width of Panel	EN 438-2 : 6	mm	+10 mm/-0	+6.0
Thickness	EN 438-2 : 5	mm mm mm	$5.0 \leq t < 8.0\text{mm}$: max ± 0.4 $8.0 \leq t < 12.0\text{mm}$: max ± 0.5 $12.0 \leq t < 16.0\text{mm}$: max ± 0.6	± 0.28 ± 0.30 ± 0.40
Straightness of Edges	EN 438-2 : 7	mm/m	1.5mm/m max deviation	1.0
Squareness	EN 438-2 : 8	mm/m	1.5mm/m max deviation	1.0
Resistance to Surface Wear	EN 438-2 -10	Revolutions (min)	350 (min.)	375
Resistance to Immersion in Boiling Water (2 hours)				
a) Mass Increase	EN 438-2 - 12	%	2.0 (max.)	0.45
b) Thickness		%	2.0 (max.)	0.58
c) Appearance		Rating (min)	Not worse than 4	≥ 4
Resistance to Impact by Large Diameter Ball (Shatter resistance)				
a) Drop Height	EN 438-2 - 21	mm	1800 mm (Drop Height)	1800
b) Diameter of Indentation		mm	10 (max)	6
Resistance to Scratching	EN 438-2 - 25	N (Force)	2.0 (min.)	2.2
Resistance to staining Group 1 & 2	EN 438-2 : 26	Rating (min)	5	5
Group 3		Rating (min)	4	4
Dimensional Stability at Elevated Temperature				
a) Longitudinal	EN 438-2 : 17	%	0.30(max.)	0.18
b) Transverse		%	0.60 (max)	0.32
Resistance to Cigarette Burns	EN 438-2 - 30	Rating (min)	Not worse than 3	3
Resistance to water vapour	EN 438-2 - 14	Rating (min)	Not worse than 4	4
Resistance to Crazeing	EN 438-2 - 24	Grade (min)	Not worse than 4	4
Panel Surface Visibility	EN 438-2 : 4	(Dirt, spots, any similar surface defects). Fibre, hair, scratches similar surface defects,	$\leq 2 \text{ mm}^2/\text{m}^2$ $\leq 20 \text{ mm}/\text{m}^2$	< 2 12
Edge Quality of panel	EN 438-6 :2005	mm	$< 3\text{mm}$	1.5

MECHANICAL PROPERTIES

Properties	Test Method As Per DIN En 438 : 2005	Unit	Specified value as per BSEN 438-4: 2005	Greenlam Clads Values
Flexural Modulus (Stress)	EN ISO 178:2003	Mpa	9000 (min.)	≥ 9650
Flexural Strength (Stress)	EN ISO 178:2003	Mpa	80 (min.)	≥ 95
Tensile Strength (Stress)	EN ISO 527-2:1996	Mpa	60 (min.)	≥ 72
Density	EN ISO 1183 -1:2004	g/cm ³	1.35	1.38
Resistance to Wet Heat Conditions	EN 438-2-15	% max. in mass increase	5	≤ 3.2
		Appearance (min)	4	4

Technical Offering:

LIGHT FASTNESS AND WEATHER RESISTANCE

Properties	Test Method As Per DIN EN 438 : 2005	Unit	Specified value as per BSEN 438-4: 2005	Greenlam Values
Resistance To Artificial Weathering Including Light Fastness	EN 438-2-29	Contrast	Grey Scale Rating not worse than 3 after 650J/M ² Radiant Exposure	3 ~ 4
		Appearance	Rating Minimum 4 after 650J/M ² Radiant Exposure	4 ~ 5
Resistance to UV Light	EN 438-2-28	Contrast	Grey Scale Rating not worse than 3 after 1500 hours exposure	3 ~ 4
		Appearance	Rating min 4 after 1500 hours exposure	4 ~ 5
Resistance to climatic shock				
Flexural strength index (Ds)	EN 438-2 : 19	Index	≥ 0,95	≥ 0,95
Flexural modulus index (Dm)	EN 438-2 : 19	Index	≥ 0,95	≥ 0,95
Appearance	EN 438-2 : 19	Rating	≥ 4	≥ 4

FIRE PERFORMANCE PROPERTIES

Properties	Test Method As Per Din EN 438 : 2005	Units	Specified value as per BSEN 438-4: 2005	Greenlam Clads Values
Europe				
Reaction to Fire	Classification Standards EN 438-7 & EN 13501-1:2007 Tested according to EN 13823:2010 & EN 11925-2:2010	Euroclass	Classification t ≥ 6 mm.	B-S2, d0
		Euroclass	Classification t ≥ 8 mm. in (Metal Frame)	B-S2, d0
Reaction to Fire (Germany)	DIN 4102-1	Class	B1	B1
Reaction to Fire (France)	NF P 92-501	Class	M1	M1
North America				
Material Surface Burning Characteristics				
Classification	ASTM E84/UL 723	Class	A	A
Flame Spread Index	ASTM E84/UL 723	FSI	0-25	0-25
Smoke Developed Index	ASTM E84/UL 723	SDI	0-450	0-450
Asia Pacific				
Reaction to Fire (China)	GB 8624	Class	B-S1, d0, t1	B-S1, d0, t1

Please note: Greenlam CLADS is engineered for vertical exterior wall coverings such as façade cladding, balcony panelling. For other applications please contact your local representative.

Warranty:

Greenlam warrants the quality of Greenlam Clads Exterior Grade Compact Laminates is as per the technical specifications and standards as mentioned above and these products are free from any manufacturing defects. In case of claims Greenlam's liability is limited only to the cost of products. Greenlam is expressly not liable for defects in the substructure or defective installation as they have no control over the execution of these. The local building regulations are to be followed without fail – we accept no liability with regard to these. All information corresponds to the current state of the technology. Suitability for particular applications cannot be confirmed in general.

Greenlam CLADS Installation Methods:

Exterior Grade Compact Panels can be installed using various methods. These methods and usage vary by geographies. This section highlights primarily two universally used methods of installation.

Method 1: Mounting of CLADS panels with rivets on an Aluminium substructure

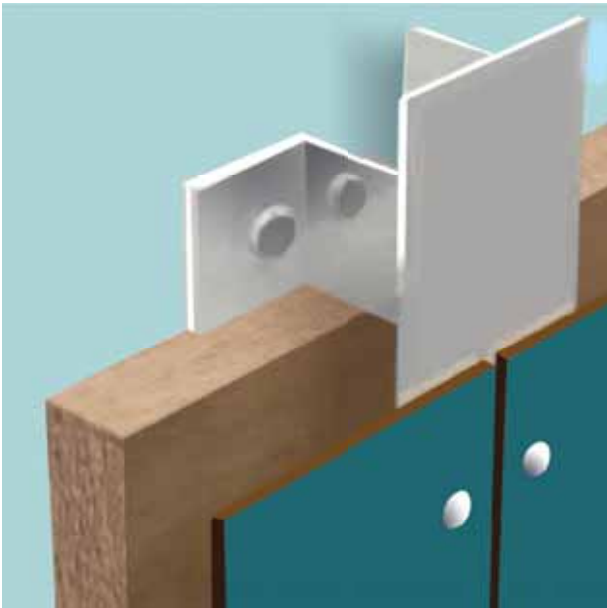

Greenlam CLADS Panels of 6 mm, 8 mm & 10 mm are suitable for riveted system on an aluminium substructure. This system is applied to high rise buildings or used as supporting gluing systems to provide extra solidity.

Substructure

The aluminium substructure has to adhere to national standards and has to be installed in accordance with the manufacturer specifications for the substructure. The aluminium substructure basically consists of vertical support profiles which are mounted on the wall using angle brackets. Due to the material properties of Greenlam CLADS panels, fixed points and sliding points need to be made in order to fix the panels.

Metal sub-structures change their dimensions with change in temperature. The dimensions of CLADS, however, alter under the influence of changing relative humidity. These changes in the size of sub-structure and cladding material can be opposite to each other. When installing, attention must be paid to the expansion clearance. The rule of thumb for calculating the required expansion clearance is:

$$\frac{X \text{ or } Y \text{ (in mm)}}{500} = \text{Expansion Clearance}$$

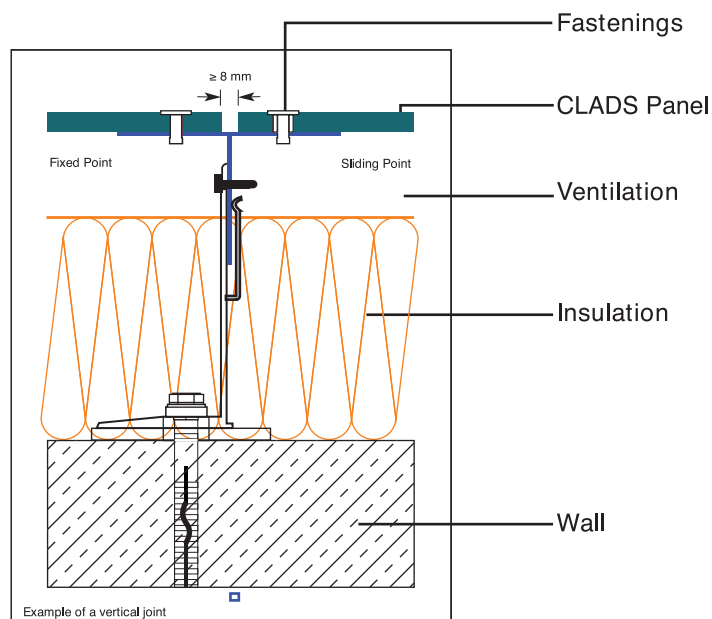

Greenlam CLADS Installation Methods:

Fixed points

Fixed Points are used for uniform distribution of the expansion and shrinkage movements. The diameter of the drill hole in Greenlam CLADS must measure 5.1 mm.

Sliding Points

The diameter of the drill hole in Greenlam CLADS must be drilled larger than the diameter of the fastening, depending on the required expansion clearance. This is the shaft diameter of the fastening plus 2 mm for every meter of cladding material starting from the fixed point. The head of the fastening must be big enough so that the drill hole in CLADS is always covered. The fastening is placed in such a way that the panel can move. Rivets are put in place with flexible mouthpieces. The defined clearance of the rivet head to the surface of the panel (0.3 mm) allows movement of the element in the drill hole. The centre point of the drill hole in the sub-construction must coincide with the centre point of the drill hole in the CLADS panels. Drill with a centring piece. The fastenings should be put in place starting from the middle of panel outwards.

Table 1

Greenlam CLADS – Mechanical Fastening Installation (Single Span Panel)			
Thickness	Maximum Distance between holes from Edges (b)	Maximum Distance between Holes in width (c)	Maximum Distance between Holes in length (a)
6 mm	20-60 mm	470 mm	600 mm
8 mm	20-60 mm	620 mm	770 mm
10 mm	20-60 mm	770 mm	920 mm

Table 2

Greenlam CLADS – Mechanical Fastening Installation (Double Span Panel)			
Thickness	Maximum Distance between holes from Edges (b)	Maximum Distance between Holes in width (c)	Maximum Distance between Holes in length (a)
6 mm	20-60 mm	600 mm	600 mm
8 mm	20-60 mm	770 mm	770 mm
10 mm	20-60 mm	920 mm	920 mm

Greenlam CLADS Installation Methods:

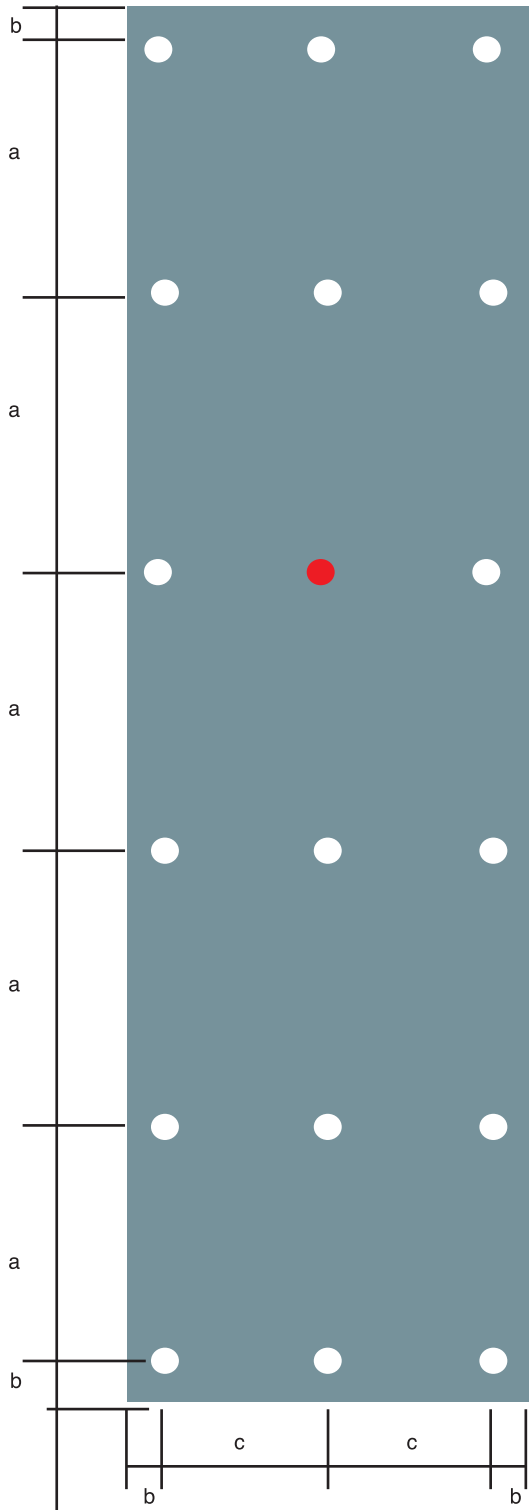

Double Span Panel

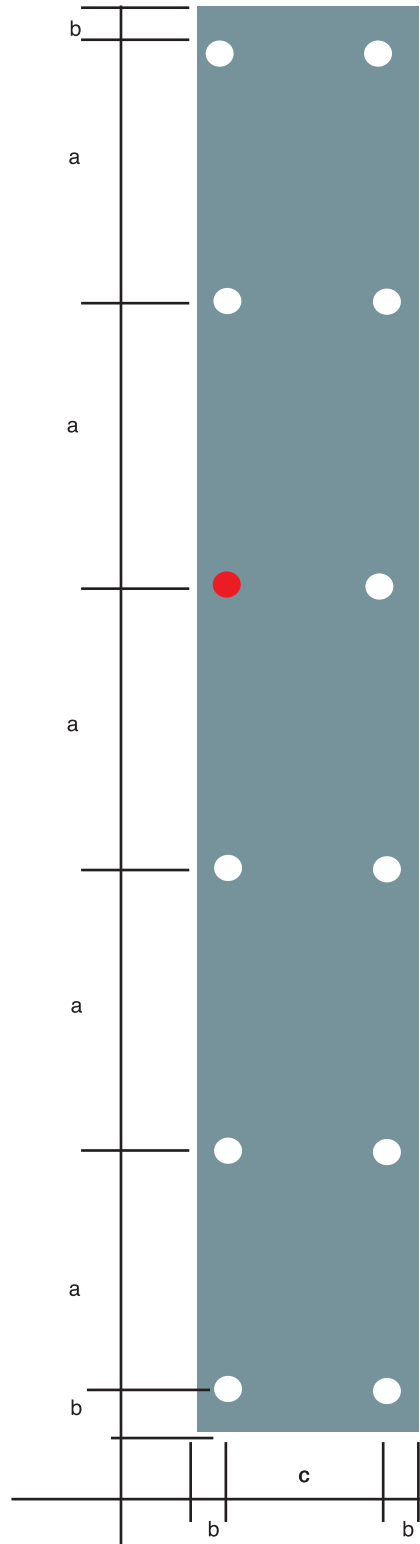

Single Span Panel

 Fixed Point

 Sliding Point

Greenlam CLADS Installation Methods:

Edge Spacing

For reasons of stability and flatness, the edge spacing must be kept in consideration, without fail. The joints must be made at least 8 mm wide so that changes in size can take place without any hindrance.

Fastening Spacing

These are to be chosen in accordance with the structural engineering requirements (calculations), or, if this is not necessary due to the local regulations. In the edge region of the construction, the spacing of the fastenings is to be kept smaller than the spacing in the central region (pressure, suction).

Fastenings

We recommend using only fastening (riveting) which is especially developed for Greenlam CLADS. These rivets are made available along with the product.

Diameter of drill hole in Greenlam CLADS panels:

- Sliding points: 8.5 mm or as required
- Fixed points: 5.1 mm
- Diameter of drill hole in the aluminium substructure: 5.1 mm

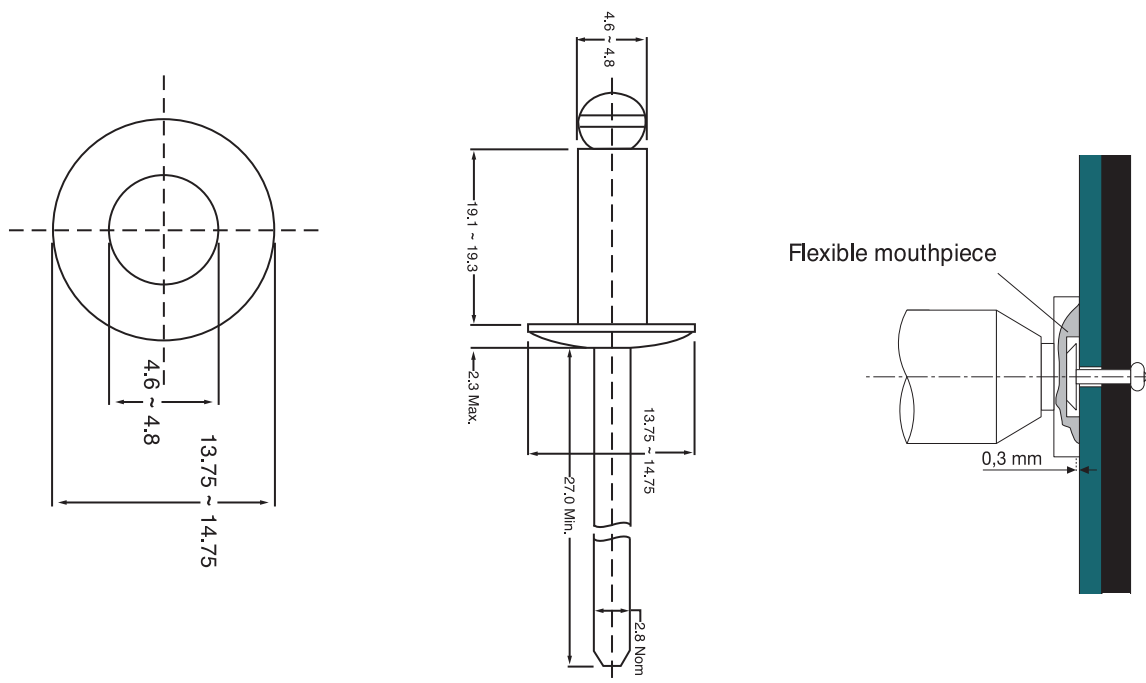

The rivets must be put in place with a flexible mouthpiece, clearance 0.3 mm.

Greenlam CLADS Installation Methods:

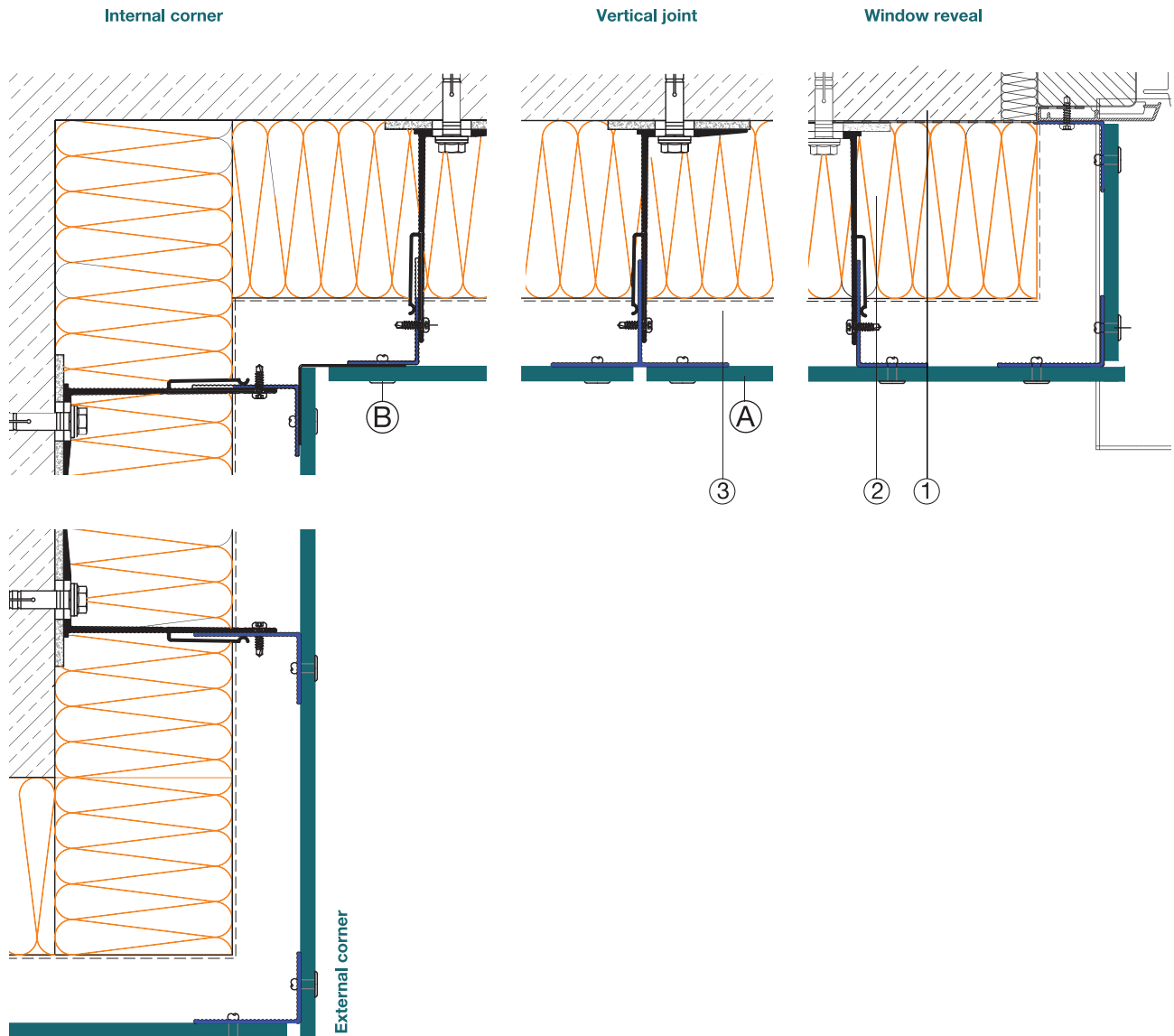

Vertical sections on Alu-substructure riveted

All profiles and fastenings shown in this brochure are planning suggestions, and are not part of the Greenlam delivery programme.

Legend:

- ① Wall
- ② Insulation
- ③ Ventilation
- Ⓐ CLADS Panel
- Ⓑ Fastenings

Greenlam CLADS Installation Methods:

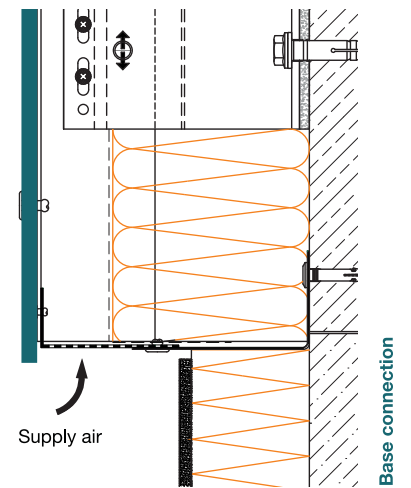
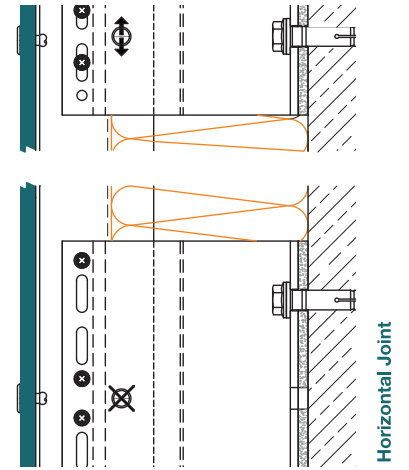
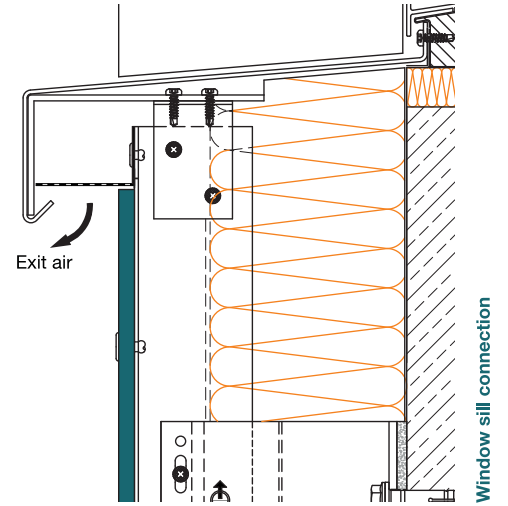
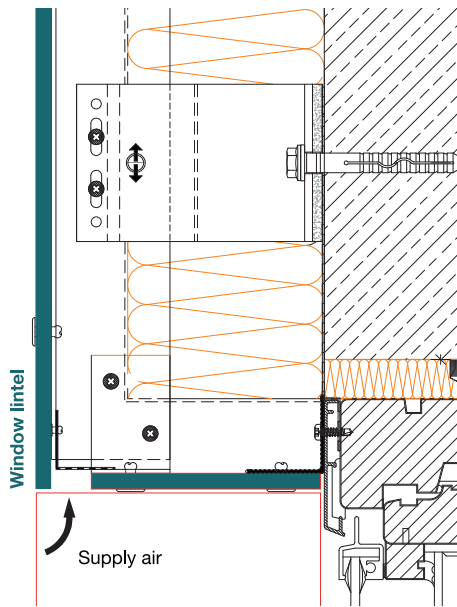
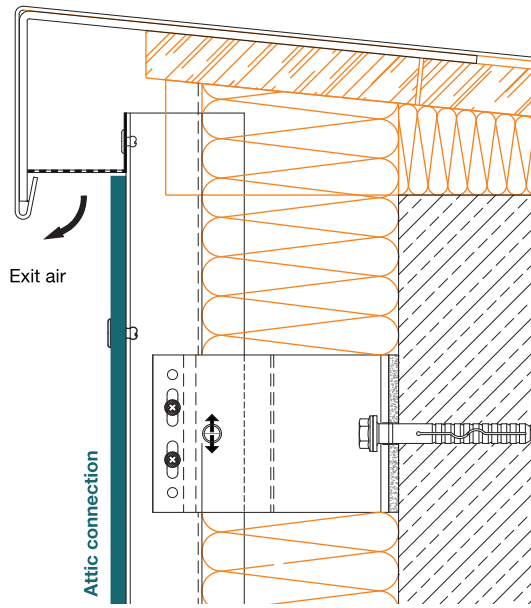

Vertical sections on Alu-substructure riveted

Greenlam CLADS Installation Methods:

Method 2:

Secret Glued Fastening with Gluing Systems

An alternative to visible mechanical fixing with rivets is gluing the CLADS facade panels with gluing systems which were specially developed for this purpose. It works on normal planed aluminium sub-constructions. Gluing is a clean and simple solution for rear-ventilated facades, attics, visible roof underfaces, reveals, etc. As a prerequisite, permission must be sought from the authorised building officials of the region/country. Following are the products that are used to bond high pressure laminates using Panel Lock system.

- 3M PU 540 Sealants
- 3M™ VHB™ G23F Structural Glazing Tape
- 3M PU Primer 595 Black

Both the sealant and VHB tapes are very durable chemistry and are resistant to UV radiation. While VHB tape gives immediate holding strength and ensure consistent sealant bead thickness, the 540 PU sealant provides the additional anchorage against possible cleavage stresses on the edges due to wind load.

Working Sequence for Installing Greenlam CLADS Using Secret Glued Fastening System:

Following are the steps in general, to be followed for getting the optimum results with 3M™ Panel

- Aluminum substructure Creation
- Surface Preparation & Priming
- VHB & Sealant Application
- Panel Cladding

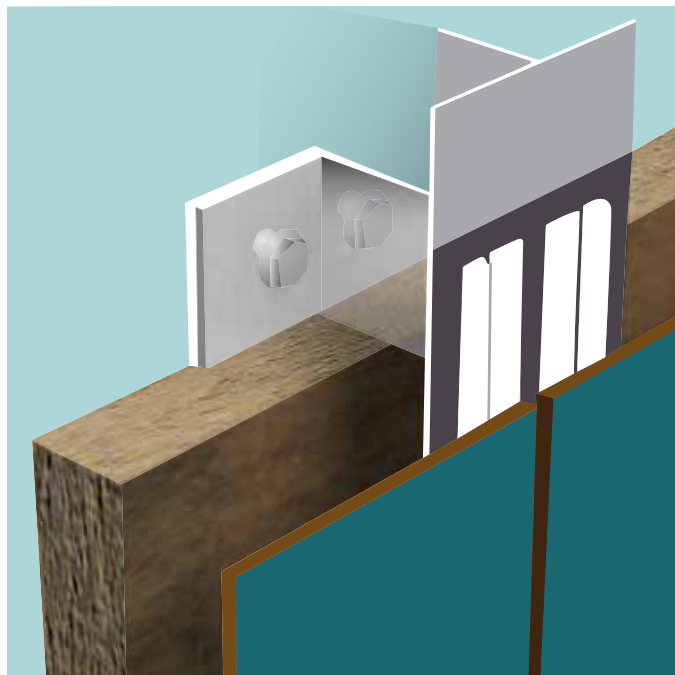

Greenlam CLADS Installation Methods:

Substructure

The aluminium substructure has to adhere to national standards and has to be installed in accordance with the manufacturer specifications for the substructure. The aluminium substructure basically consists of vertical support profiles which are mounted on the wall using angle brackets.

Edge Spacing

For reasons of stability and flatness, the edge spacing must be kept in consideration, without fail. The joints must be made at least 8 mm wide so that changes in size can take place without any hindrance.

Metal sub-constructions change their dimensions with change in temperature. The dimensions of CLADS, however, alter under the influence of changing relative humidity. These changes in the size of sub-construction and cladding material can be opposite to each other. When installing, attention must be paid to the expansion clearance. The rule of thumb for calculating the required expansion clearance is:

$$\frac{X \text{ or } Y \text{ (in mm)}}{500} = \text{Expansion Clearance}$$

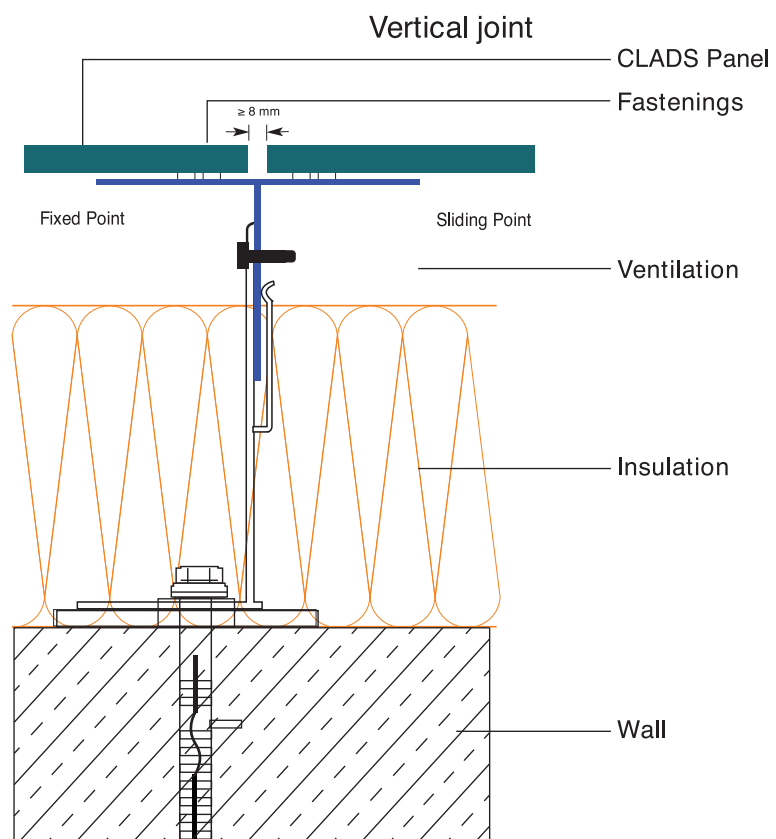

Greenlam CLADS Installation Methods:

Surface Preparation & Priming

- **Abrasion:** The bonding area on both the metal frame surface and backside of the HPL are abraded using a cleaning pad/ fine emery paper. Do not use a coarse abrasive product; use emery paper finer than #220 grit. Abrasion will remove any scales/ oxide/ LSE coating, and will also improve adhesion by creating very fine scratches.
- **Surface cleaning :** The surface is cleaned of dust after the abrasion first with a dry cloth and then with 3M PU cleaner. Do the cleaning by wiping in single direction and allow the solvent to evaporate.
- **Priming:** To promote the adhesion and for a durable bond the surface need to be primed – with 3M PU Primer 595 black. The primer can be applied either with a brush or with a swab, to get a uniform coating on the surface. The black film should be continuous with a single wipe in one direction. Soak the swab with enough primer to achieve this in one stroke; it is not recommended to reverse the direction of the swab while applying primer. The primer should be applied only on the bonding areas and allowed to dry to leave a tack free film. The surface preparation of the HPL panel is done just before bonding but before sealant application on the frame. The bonding should be completed at the earliest to avoid any dust accumulation on the surface.

VHB & Sealant Application

- **VHB Application:** It is advised to apply VHB before even opening the sealant pack, as extended exposure of sealant bead will cause skin formation. Unwind sufficient length of VHB tape from the roll, hold the edge of the tape, and leave the portion where it is touched by the fingers outside. Press the tape end to the frame, align the tape to the outer edge of the frame, and press the tape down from one edge to the other. It is recommended to use 3M HTA for bubble free application of the tape. Give an overlap wherever the tape needs to be joined, and then cut the overlapping edges of the tape to get a neat but-joint. Press the tape with squeegee or rubber roller to ensure proper surface contact and to initiate the flow.
- **Sealant Application:** It is recommended to apply the sealant as a triangular bead of 6-8 mm base and height, approx 10-12 mm away from the tape. The nozzle of the sealant sausage/ cartridge is cut at proper length with a 'V' notch to get the triangular bead with the dimensions mentioned. The sealant application and cladding should be completed within the skin formation time of the sealant, restrict the area of application in one go accordingly. Apply sealant as a continuous bead with uniform dimensions. The triangular shape of the bead will help to get maximum contact area between sealant and panel when squeezed, and a near rectangular bead.

Panel Cladding

Remove the liner from the tape, place the panel to be bonded over the tape and sealant bead, without pressing. At this point the panel can be moved to get a proper alignment, as it is not touched on the tape surface. Make sure that there is not much movement while aligning, once the panel touches the sealant bead, to avoid any contamination of tape bonding surface with sealant. Once the alignment is properly done, push the panel to lock it in place and then press down with a rubber roller or by hand pressure. Bond strength is dependent upon the amount of adhesive-to-surface contact developed. Enough pressure should be applied so that both surfaces fully contact the tape; the bond strength will increase as the adhesive flows onto the surface.

Greenlam CLADS Installation Methods:

Please note using the gluing system for installing Greenlam CLADS panels needs optimum curing time so as to attain the best possible bonding for VHB tape, at room temperature between the aluminum substructure and compact laminate panels.

- 50% of the ultimate strength in 20 minutes
- 90% after 24 Hrs
- 100% strength is attained after 72 Hrs

The sealant cure rate depends on the temperature, and humidity and is mentioned in the technical datasheet.

For glued installation (spacing of the vertical support construction)		
Panel thickness	Maximum fastening spacing single span panel	Maximum fastening spacing double span panel
6 mm	450 mm	500 mm
8 - 10 mm	600 mm	650 mm

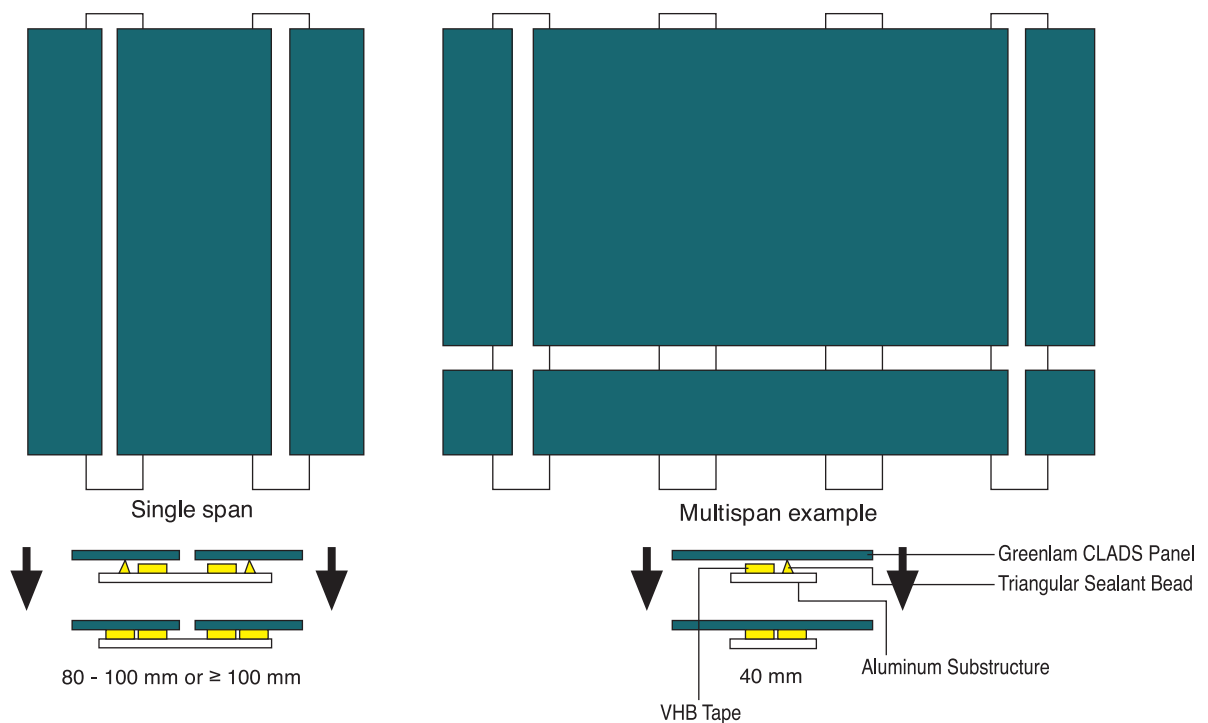

Important Points to remember :

- # Surface preparation is a basic requirement to ensure proper adhesive contact to the base surface
- # VHB won't allow any air to pass through it, apply it without air bubbles
- # Don't use VHB / sealant bead in pieces, but use in continuous length
- # Complete the bonding before skin formation happens on the sealant bead
- # Pressing down the tape is necessary to initiate flow and to ensure proper surface contact
- # Follow the safety instructions and handling precautions given in the respective datasheets/ MSDS while handling solvents and primer

Greenlam CLADS Installation Methods:

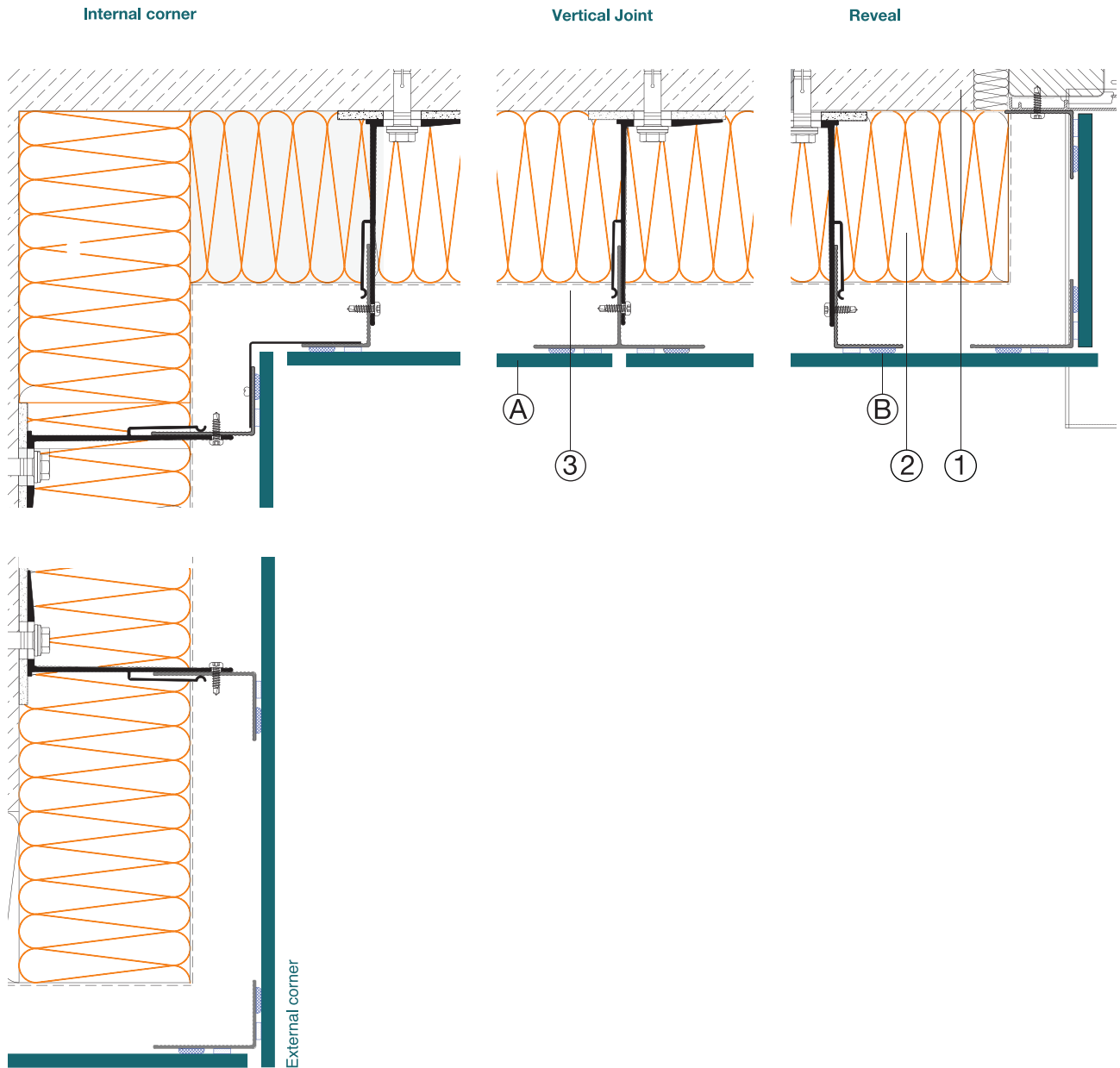

Vertical sections on Alu-substructure glued

All profiles and fastenings shown in this brochure are planning suggestions, and are not part of the Greenlam delivery programme.

Legend:

- ① Wall
- ② Insulation
- ③ Ventilation
- Ⓐ CLADS Panel
- Ⓑ Fastenings

Greenlam CLADS Installation Methods:

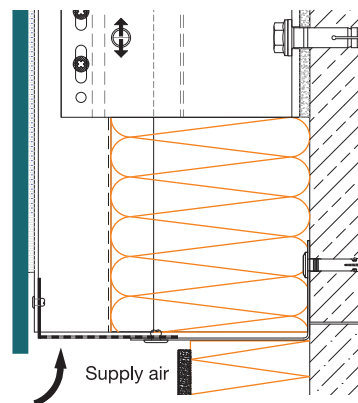
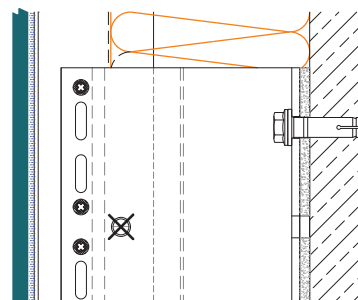
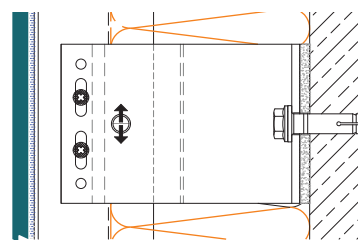
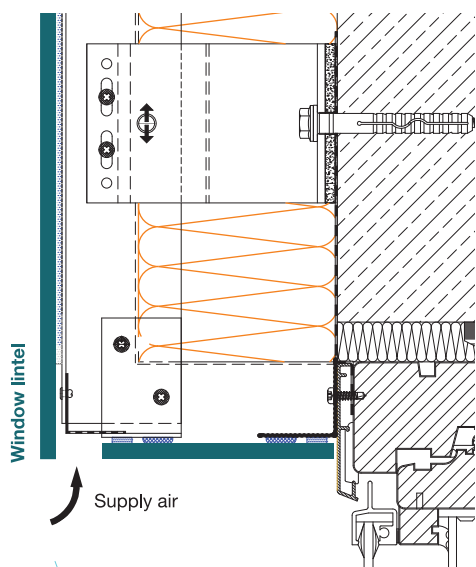
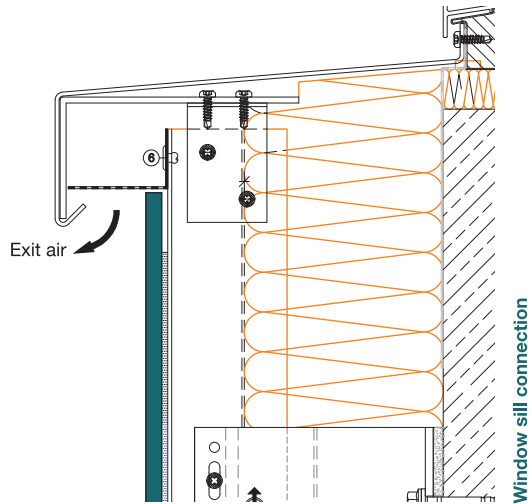
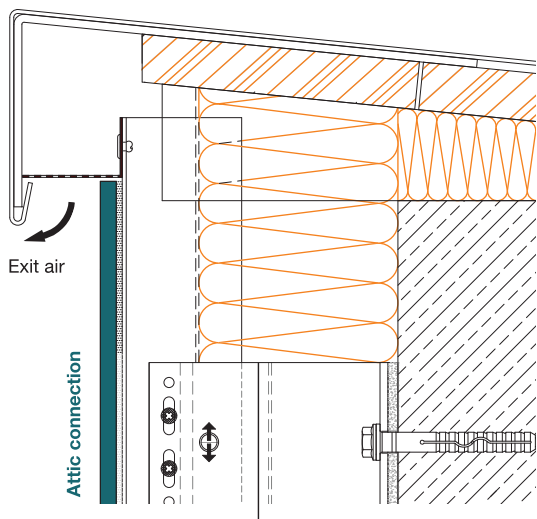

Vertical sections on Alu-substructure glued

WOODS



9102 Innate Wenge



9104 Enigma



9109 Snake Wood



9107 Lorraine Walnut



9101 Heather Pine

Greenlam CLADS: Range Offering



9103 Smoldered Wood



9108 Arch Wood



9110 Pure Walnut



9106 Coral Streak



9105 Caramel Streak

ABSTRACTS



9202 Eldorado



9203 Cementrio



9205 Citron Stone



9206 Lava Stone



9201 Premio



9204 Metropolitan

SOLIDS



9273 Murky Grey



9272 Oyster



9275 Vermilion Red

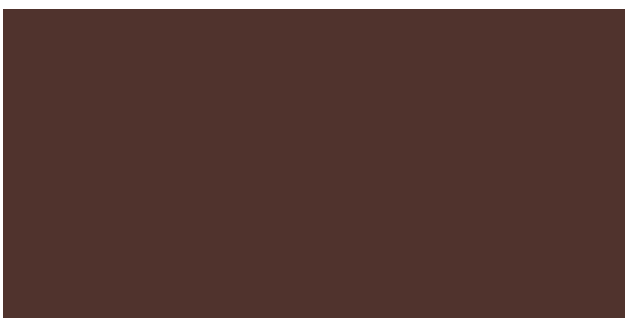

9274 Choco Brown

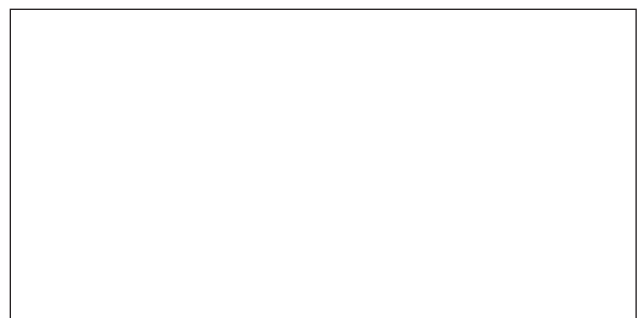

9271 Clear White



Greenlam
LAMINATES

INDIA : info@greenlam.com **EUROPE** : info.eur@greenlam.com **NORTH AMERICA** : info.us@greenlam.com **SINGAPORE** : info.sg@greenlam.com
THAILAND : info.th@greenlam.com **CHINA** : info.cn@greenlam.com **HONGKONG** : info.hk@greenlam.com **INDONESIA** : info.id@greenlam.com
MALAYSIA, EAST : info.em@greenlam.com **MALAYSIA, WEST** : info.wm@greenlam.com **VIETNAM** : info.vn@greenlam.com
PHILIPPINES : info.ph@greenlam.com **MAYANMAR** : info.mm@greenlam.com **TAIWAN** : info.tw@greenlam.com

www.greenlamclads.com

